

Varenummer: 204380M2075D0T
 Beskrivelse: E+G Justerfod
 GN 43-80-M20-75-D0-T
 Note: T Uden møtrik, spændeflade i bunden

Mål

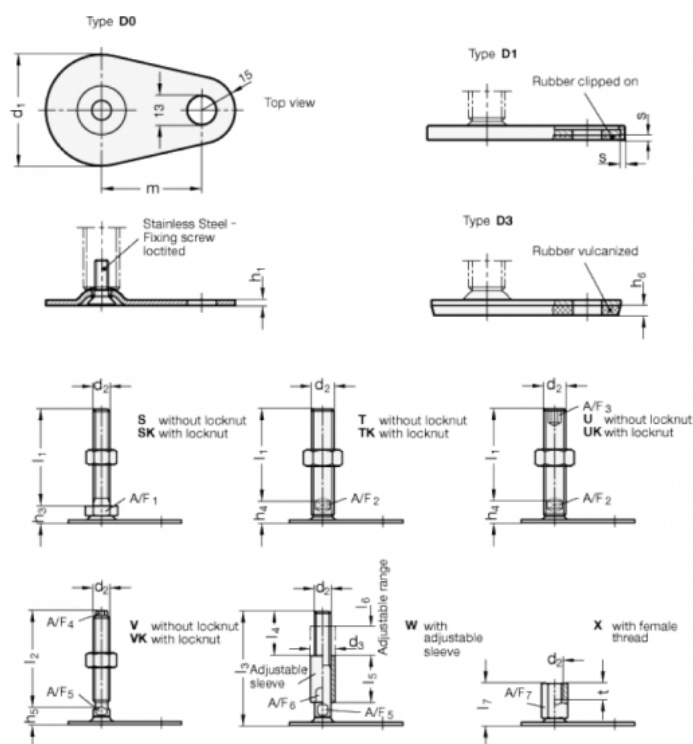

A/F2 = 15

s =

d1 = 80

d2 = M20

h1 = 3

h4 = 18

h6 =

L1 = 75

m = 70